

电源部分 5V转3.3V VCC为3.3V

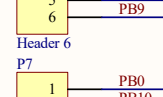

连接W5500模块 (HS-WIZ550IO/WIZ850IO) J3和J4一组, J5和J6一组, 任选一组

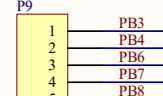
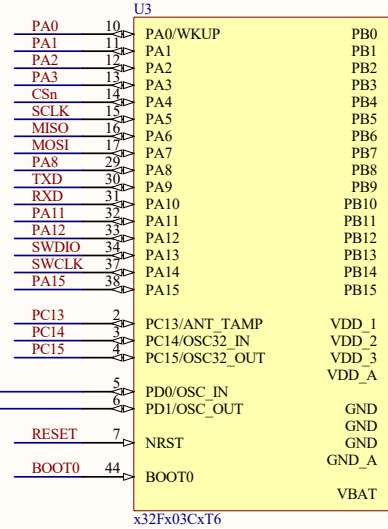
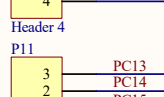
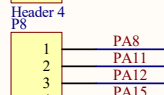
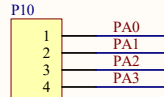
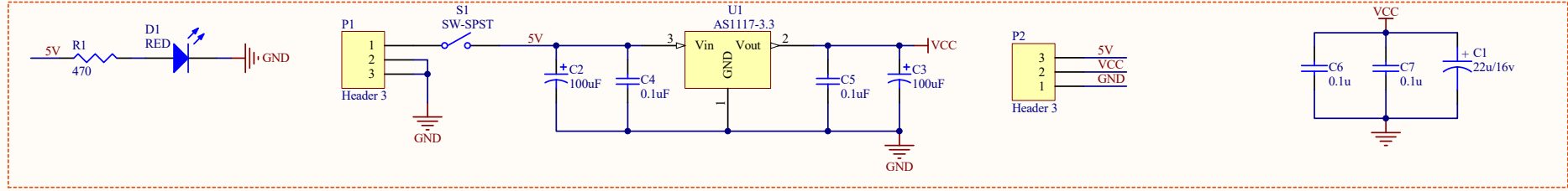
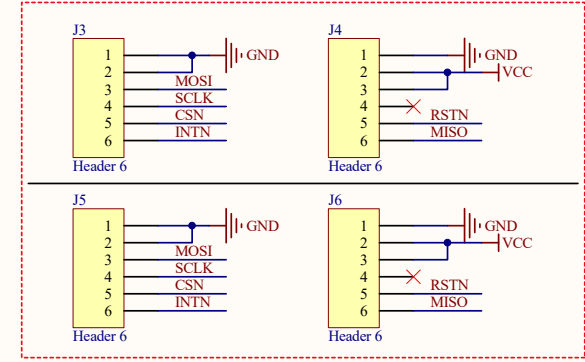

Uart和SWD

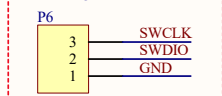
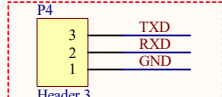

SWD有的仿真器要连接3.3V

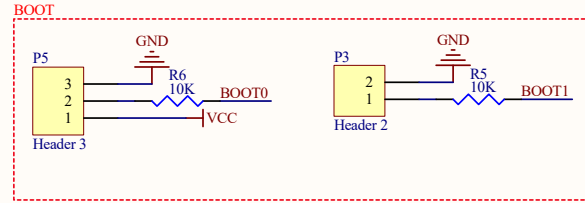
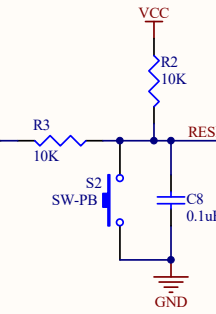
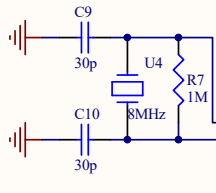

项目名称: HS-EVB32C-WIZnet(C8T6原理图)  
 公司网址: www.hschip.com  
 联系电话: 028-86127089 0755-86066647  
 技术邮箱: support@hschip.com  
 多元化物联网产品解决方案和综合服务提供商